

POLYMORPH

Polymorph is one of a new generation of plastics with unusual properties. It has a remarkably low fusing temperature of around 60°C. In other words, Polymorph can be reduced to a mouldable condition by immersion in hot water!

Once Polymorph has fused - and turns from opaque to clear - it can be moulded in many ways and stays workable until a much lower temperature. When fully cooled it is very similar in appearance and physical properties to nylon. If anything, it is stiffer, stronger and tougher than most plastics used in domestic products. It is a true thermoplastic and can be re-heated and remoulded any number of times.

MOULDING POLYMORPH

- 1) Polymorph granules are heated in a cup of hot water. Recommended temperature is about 62°C.

PRECAUTION

Only heat in hot water - do not use direct heat.

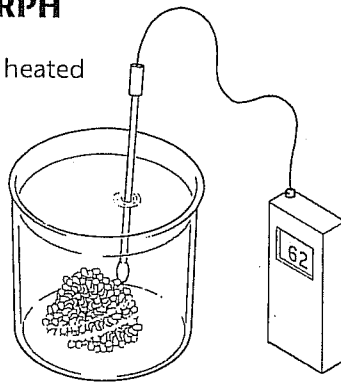

- 2) The fused polymorph granules are carefully removed from the hot water using tongs or similar implement.

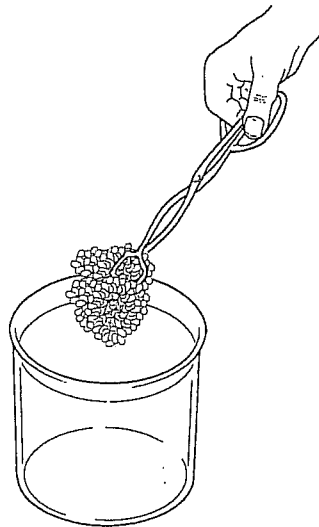

3. The water is squeezed out and the polymorph is ready to shape or form.

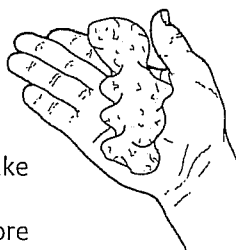

Precaution

The water may be very hot so take extra care. If necessary, let the Polymorph cool down a bit before squeezing out the water.

IDEAS FOR APPLICATIONS

Moulding around objects

Polymorph lends itself particularly to being moulded around other objects - e.g. to make a larger handle around a tool. This can be especially useful for people with certain disabilities.

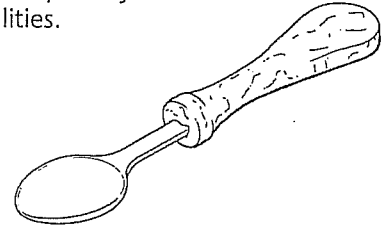
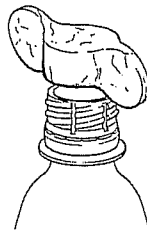

Making moulds

Because Polymorph is easily formed around other objects, it can be used for single or multiple-part mould making - providing that it can be fully pushed into smaller surface depressions.

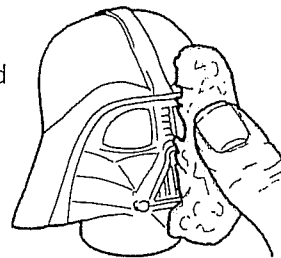

Parts for models

E.g. Polymorph can be formed into a tough spine or "skeleton" to support other materials - perhaps as part of a model puppet.

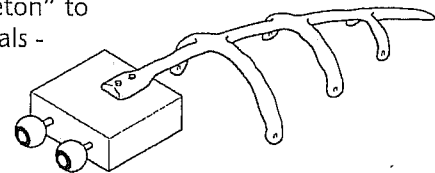

DIY

There are countless problems for which Polymorph offers solutions.

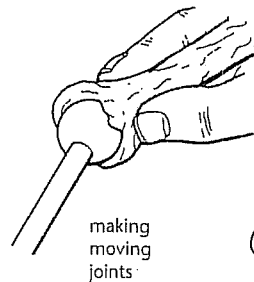

making moving joints

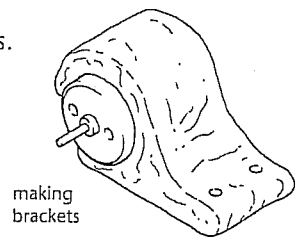

making brackets

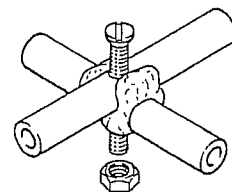

making fixed joints

Note: Polymorph is a non-toxic material that is fully biodegradable.

For further supplies of Polymorph please contact your local Maplins stockist.

POLYMORPH

POLYMORPH

Polymorph is one of a new generation of commercial plastics with unusual properties. It is one of a class of polymers known as caprolactones which have remarkably low fusing temperatures of around 60°. In other words, Polymorph can be reduced to a mouldable condition by immersion in hot water!

Once it has fused - and turns from opaque to clear - it can be moulded in a variety of ways and stays workable until a much lower temperature. When fully cooled it is very similar in appearance and physical properties to a broad range of polythenes; if anything, it is stiffer, stronger and tougher than the polythene used in domestic products. It is a true thermoplastic and can thus be re-heated and thermoformed any number of times.

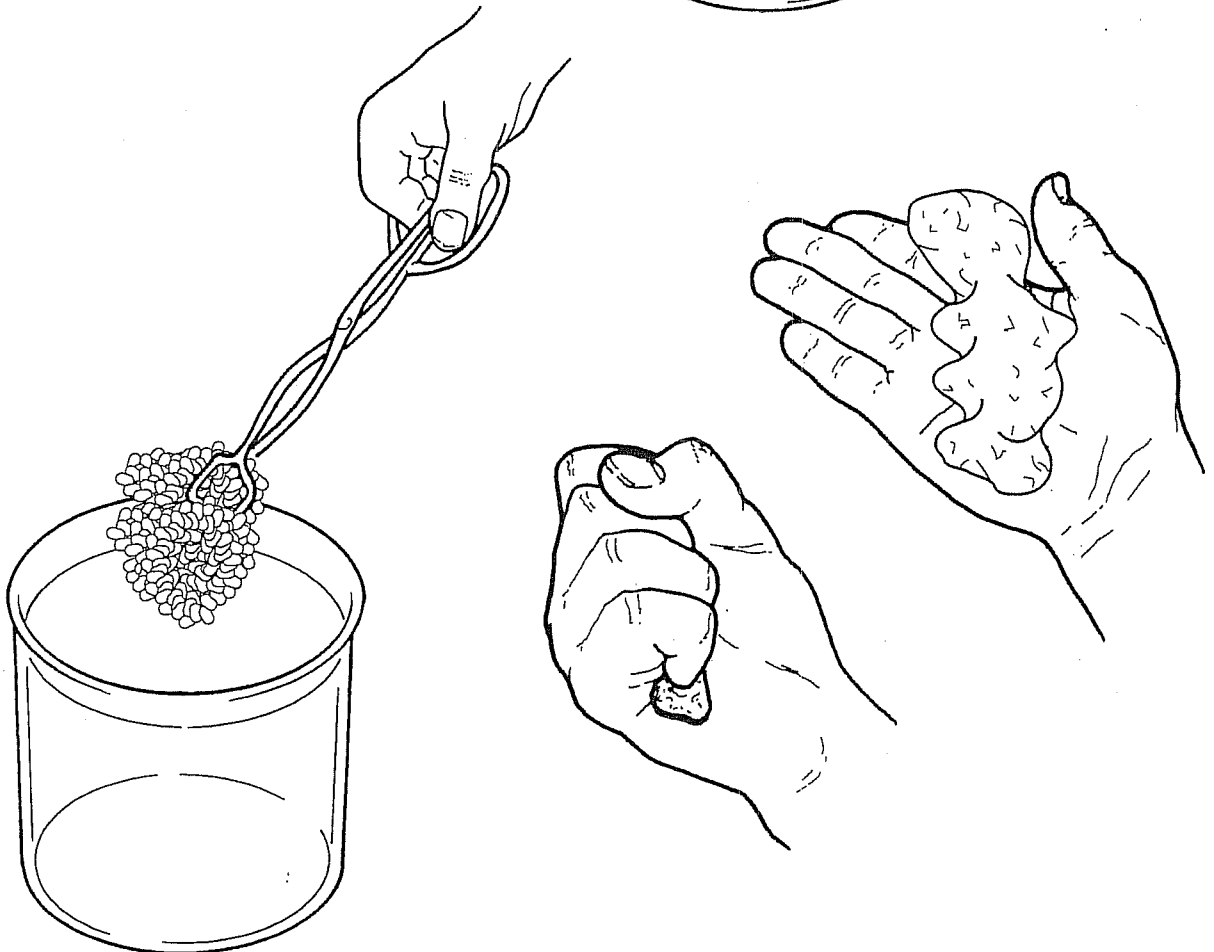
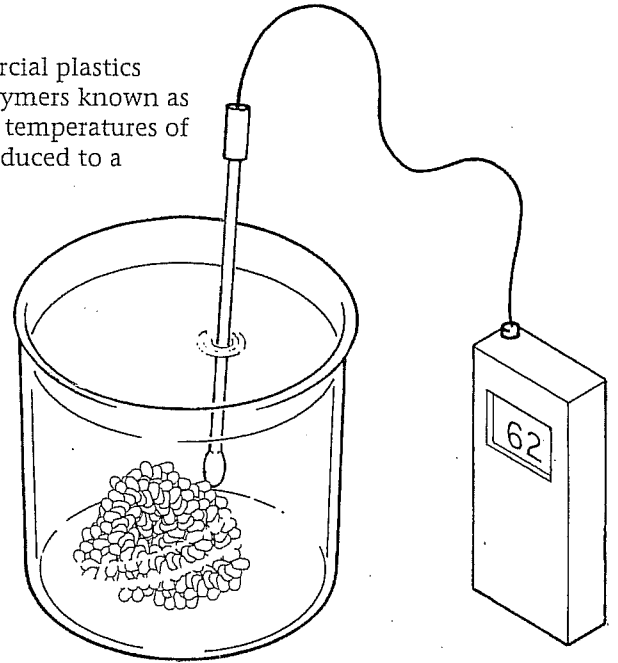

POLYMORPH

PRECAUTIONS USING POLYMORPH

UNDER NO CIRCUMSTANCES SHOULD POLYMORPH BE HEATED ABOVE THE RANGE 60°-65° MAX. ABOVE THIS TEMPERATURE IT WILL BECOME A STICKY ADHERENT MASS AND PRESENT THE SAME HAZARD AS HOT-MELT GLUE (which is one of its uses at higher temperatures). It is recommended that Polymorph is only fused in water whose temperature is monitored with a thermometer. It is not necessary to use boiling water which in itself presents a scalding hazard. With a molecular weight of 80,000, Polymorph sinks in water and will collect at the bottom of a container. When fused, the granules will adhere to each other but not to the container. The mass can be removed with tongs and squeezed to remove trapped water.

CONVERTING POLYMORPH

Polymorph can be converted into sheet or cylinder forms using very simple techniques. To create a sheet, a fused mass is placed on a flat (ideally warmed) surface and then rolled between two "shims". These guarantee a uniform thickness and parallelism of the two surfaces. The "shims" can, of course, be profiled to produce a corresponding cross section in the sheet.

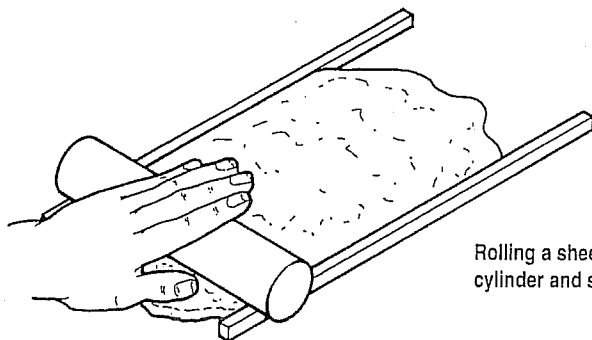

Rolling a sheet using cylinder and shims

A uniform cylinder is created by rolling a mass of Polymorph between a flat surface and flat plate - both, ideally, warmed up. Bearing balls or rollers of a known diameter placed between the plates will provide a known diameter.

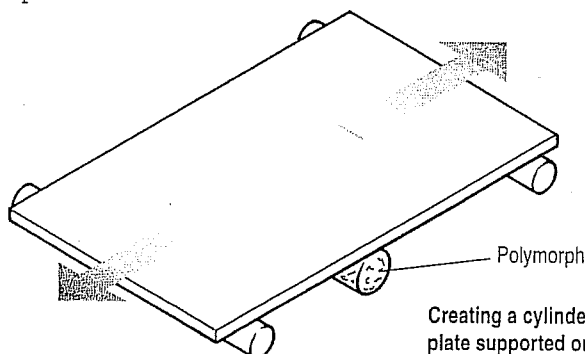

Creating a cylinder using a plate supported on rollers

In summary, the properties of Polymorph are given below:

Chemical name:
Caprolactone polymer or Oxepanone polymer

Commercial designation:
CAPA 680 (specification 118310)

Fusing point:
60-62° centigrade

Tensile strength:
580 kg/cm²

General Hazards:
Non-hazardous
[manufacturer's safety data sheet]

Colour:
Hazen

Disposal:
Biodegradable in soil

POLYMORPH

USES FOR POLYMORPH

One-off mouldings

Polymorph lends itself particularly to one-off mouldings that can be created entirely by hand or by using simple tools for profiling and smoothing. It has a potentially significant part to play in designing for disabilities where there is a specific orthopaedic or ergonomic problem to address. Because it behaves as any other thermoplastic, it is possible to mould it around inserts or on to components that would otherwise be extremely difficult to accommodate.

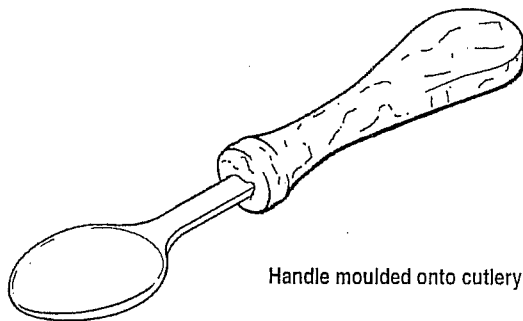

Handle moulded onto cutlery

Most hand and power tools are designed to offer as much flexibility as possible in different contexts. It can be used to improve existing hand tools or to create new ones for specific applications - e.g. a long-reach hexagonal driver tool.

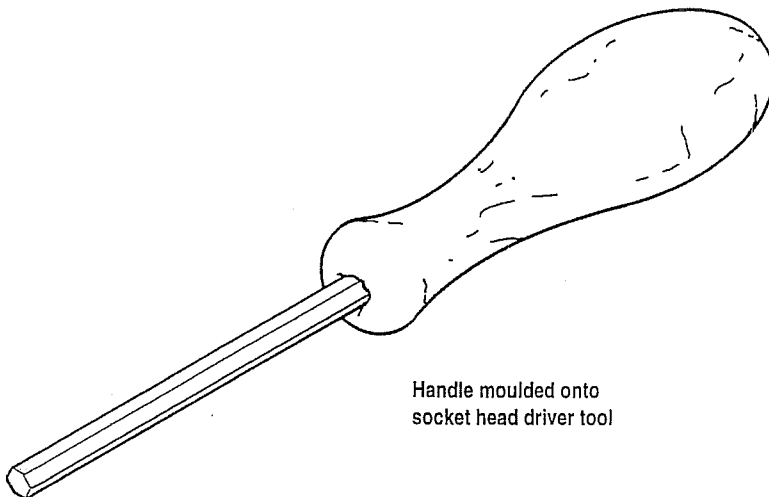

Handle moulded onto
socket head driver tool

POLYMORPH

MOULDS FOR POLYMORPH AND OTHER MATERIALS

Because Polymorph is easily formed around other objects, it can be used for single or multiple-part mould making - providing that it can be fully pushed into smaller surface depressions.

If the original pattern or object provides a simple impression mould, then Polymorph itself can be formed in the mould thus making it possible to manufacture multiple copies of an original. Model figures and even gears have been reproduced in this way.

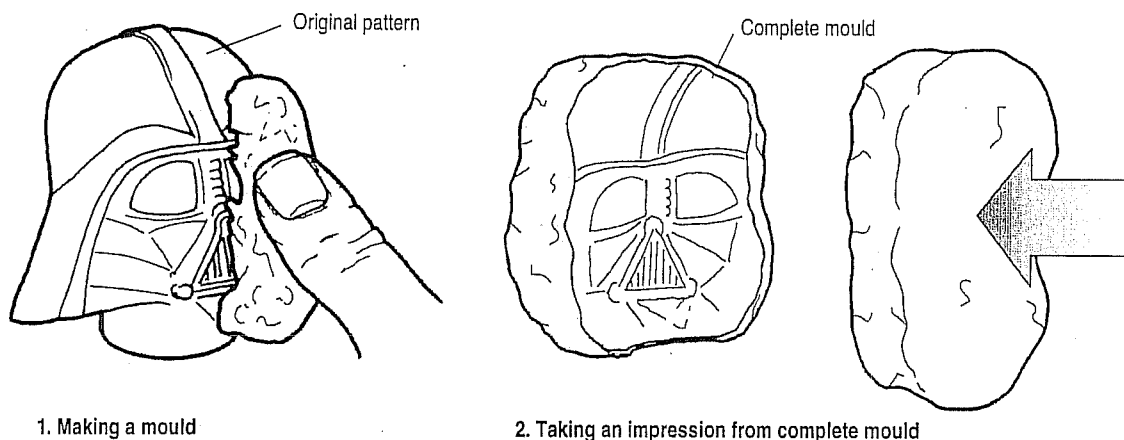

1. Making a mould

2. Taking an impression from complete mould

A complete mould can be built up around a complex pattern by applying Polymorph to one section, letting it cool and then applying more to an adjacent section - and so on. In this way the edges of each mould section will fit together when the total mould is re-assembled.

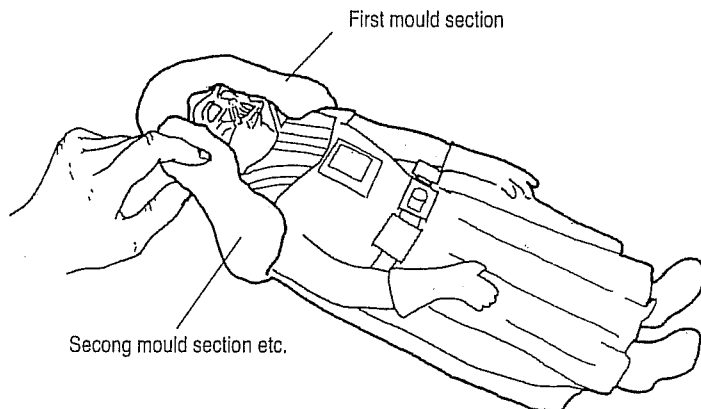

A release agent such as wax or silicon grease should be applied to the edges of each mould section before applying more Polymorph.

POLYMORPH

VACUUM FORMING MOULDS

Polymorph is an ideal vacuum mould material for vacuum forming because of its ease of moulding and ultimate mechanical strength when subject to atmospheric loading. To reduce the mass required it can be built up around other materials such as MDF but after use it can of course be re-formed. In this respect it can be much cheaper in the long term than building up and wasting away large amounts of traditional materials that are used only once.

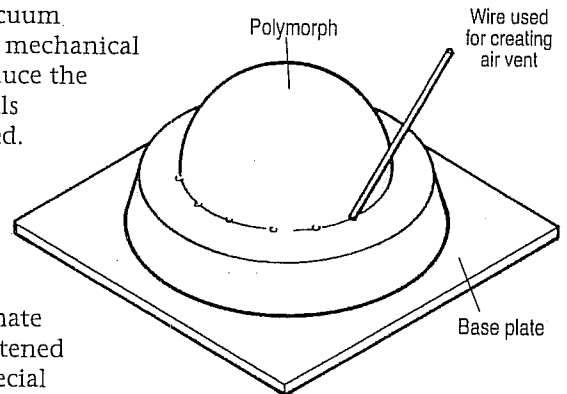

Mould making often requires very fine holes to eliminate entrapment of air that may form in pockets as the softened sheet pulls down. These are normally drilled using special techniques after a mould is finished. With Polymorph, the holes can be created by insertion and withdrawal of fine wires while the material is soft.

MECHANICAL COMPONENTS

Improvising specific mechanical components in prototype work can be extremely time consuming. Because it can be formed rapidly into almost any cross section and moulded, if necessary, around other components, it provides a remarkably rapid method of small or large scale fabrication.

In the example shown, it is necessary to make a sub-assembly of three meshing gears that run on stub axles. The gears are laid out over a slab of Polymorph and mild steel axles stubs inserted through the centres and into the Polymorph. Because of the overall contraction of the plastic, the gears should be positioned to mesh quite loosely.

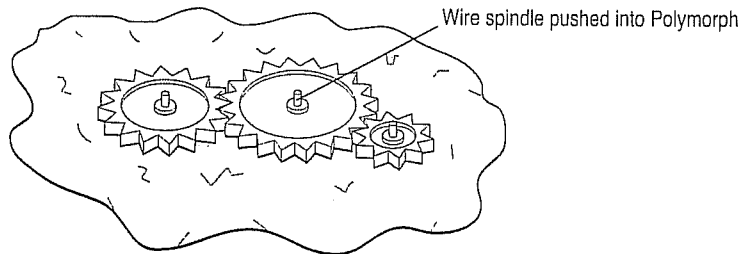

In another example a push rod terminating in screw fastenings is needed for a model. The rod is made by rolling (see above) and the screws are moulded into the ends which are softened locally by re-heating in water.

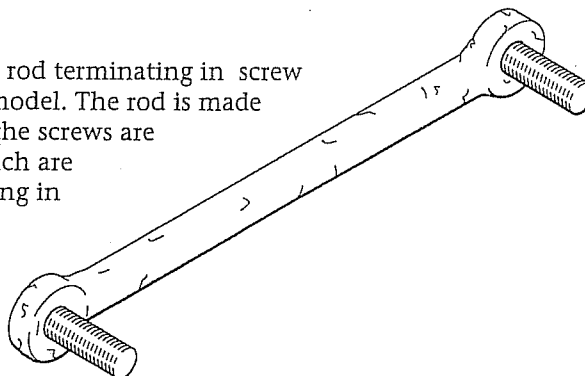

POLYMORPH

ARMATURES FOR MODELS AND COMPLIANT MATERIALS

Polymorph can be formed into a tough spine or "skeleton" to support other materials - for example, in an animated model/puppet or in a sophisticated animatronics application.

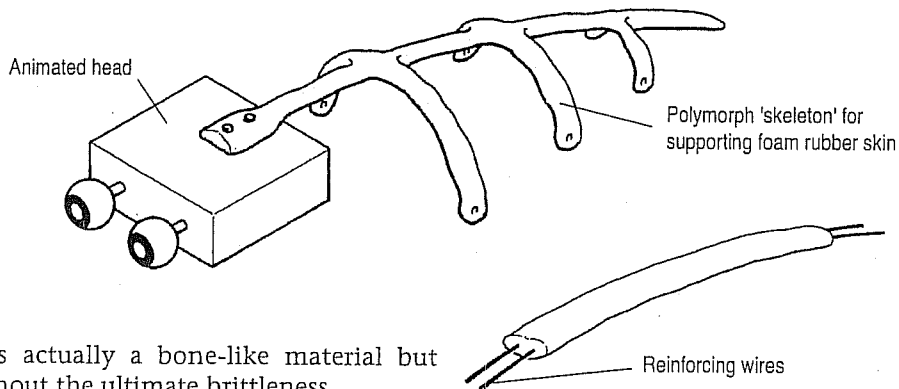

It is actually a bone-like material but without the ultimate brittleness. If necessary, it can be reinforced with one or more moulded -in wires.

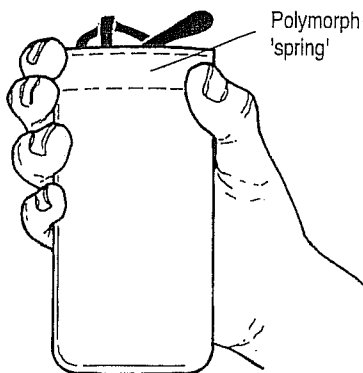

Polymorph can also be used in many situations where a fabric construction - even a garment - requires specific stiffening. An obvious example is a small case for spectacles or a mobile phone which has a sprung opening.

A container such as a rucksack can also be fitted with purpose moulded stiffeners or a partial frame. Because Polymorph is both tough and springy, it has many advantages over metal or conventional fibre inserts.

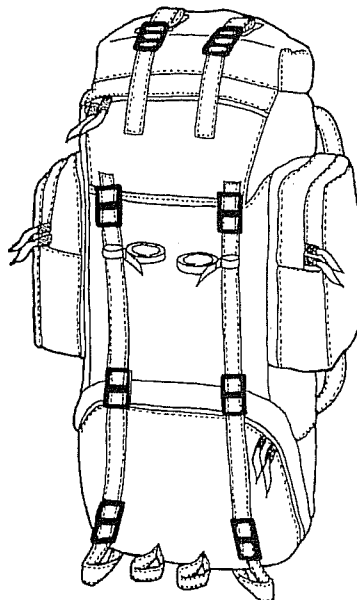

POLYMORPH

SPECIALISED PROTOTYPING

There are probably countless prototyping problems for which there are possible Polymorph solutions.

For example, a ball and socket joint can be created rapidly by moulding softened Polymorph around a ball mounted on a stem.

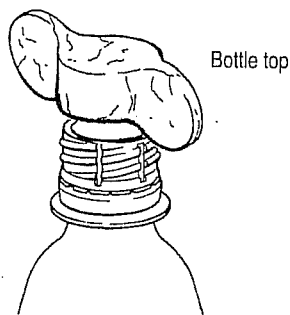
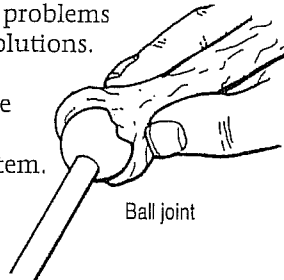

A threaded cap can be made by moulding Polymorph around a bottle top.

In many motorised models or prototypes, it is always a problem to hold the motor, battery or other sub-assembly. Polymorph can be formed around a motor and further moulded to form an attachment point. A motor can thus be accommodated easily where awkward angles might preclude an easy "bolt-down" solution.

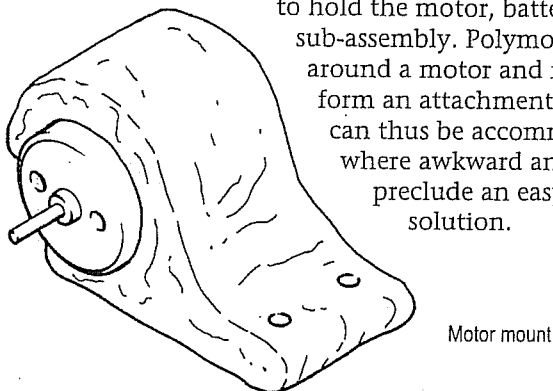

An especially interesting application is the manufacture of a product prototype such as a torch. It is possible here to encapsulate all components within the moulding (emulating, incidentally, a product trend where long life batteries are sealed into disposable torches). Remember that Polymorph is biodegradable and that a majority of batteries are now relatively safe to dispose of in landfills.

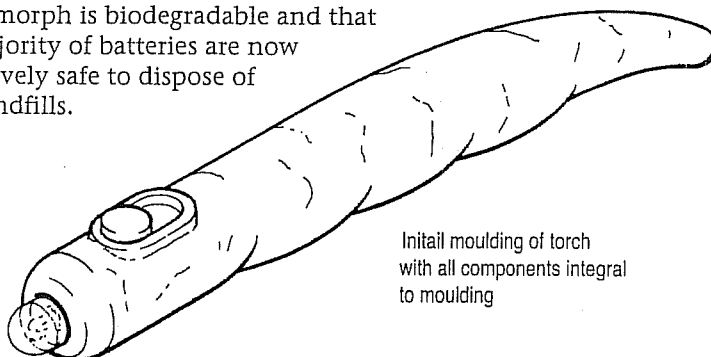

POLYMORPH

INTERFACING

Fitting prototype components together can be time consuming and costly, even to solve apparently simple problems such as joining two tubes together at 90°. Ideally, such a joint requires a transition piece having a complex profile. A softened mass of Polymorph can be squeezed between the two tubes to provide this. The joint might be completed by drilling through the components and using a machine screw and nut.

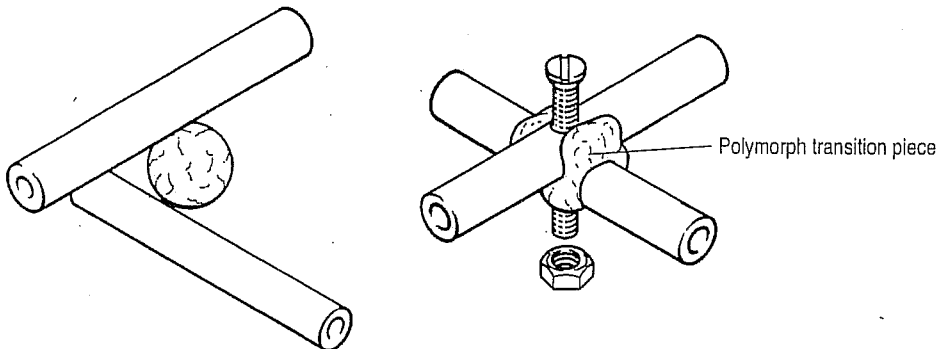

Engineering components often need to be fitted together with some degree of precision - e.g. a bearing brace within a housing. The growing use of tolerance rings - a ring formed from thin steel - eliminates the need to make the housing a perfect fit for the bearing and so reduces cost. In a prototype Polymorph can perform a similar function, although overall contraction during cooling must be taken into account if the material is formed within a cavity.

There are many other opportunities for saving time in creating quite complex components. In the example shown, a bearing race has to be fitted to a push rod threaded at both ends (part of a larger window opening system). Polymorph is used here to join the bearings to the shaft ends. Because the Polymorph forms around the screw thread, the bearing assembly can be unscrewed from the shaft if need be.

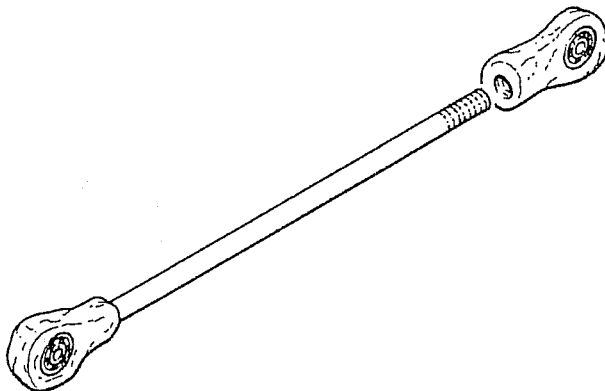

POLYMORPH

SPECIALISED COMPONENTS

It is often necessary to create a limited number of similar components as part of a product - e.g. several fastening screws or a larger screw locking handles. Both examples can be made using polymorph formed around a heagonal headed bolt. Security locks - e.g. security car wheel nuts - are often based on "keys" and mating sockets which have an arbitrary non-standard profile. This concept can be easily replicated using a formed metal key which is pressed into softened Polymorph to form the mating socket. Allowance has to be made for contraction and, of course, it has to be appreciated that high torque levels might exceed the mechanical strength of the plastic.

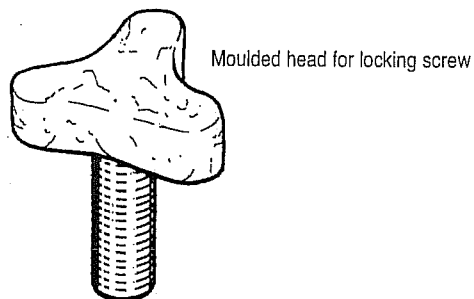

COMMERCIAL USES FOR POLYMORPH

Polycaprolactones are available in different molecular weights and each type has different physical characteristics when softened or hardened. Polymorph has the highest molecular weight and the greatest tensile strength. It is therefore more suited for applications where mechanical strength is important.

EXAMPLES OF APPLICATIONS

- Orthopaedic splints
- General DIY material
- Children's moulding medium
- Trainer/shoe components
- Hot-melt glue
- Sports protective clothing
- Component for other plastic co-polymers